

ARTURA

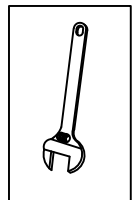

www.plus.dk

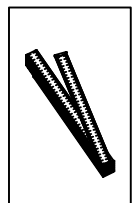
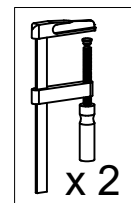
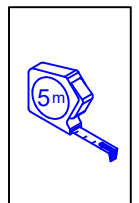
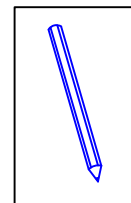
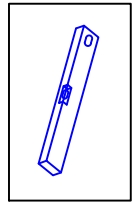
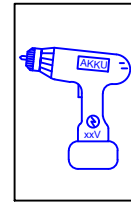
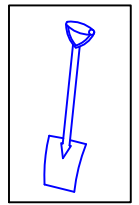
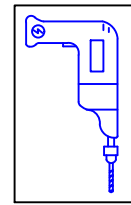
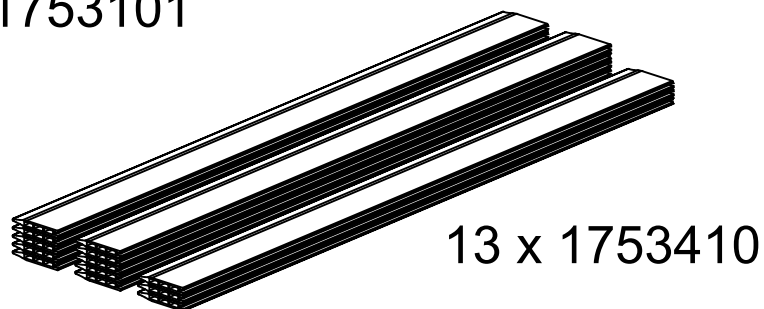
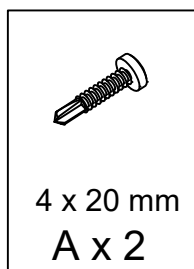
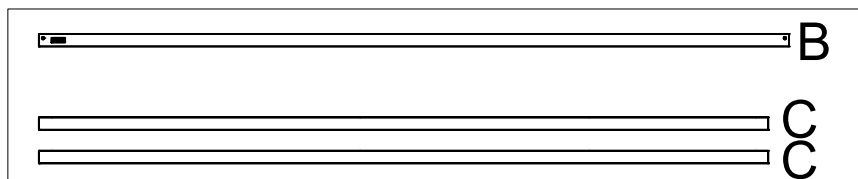
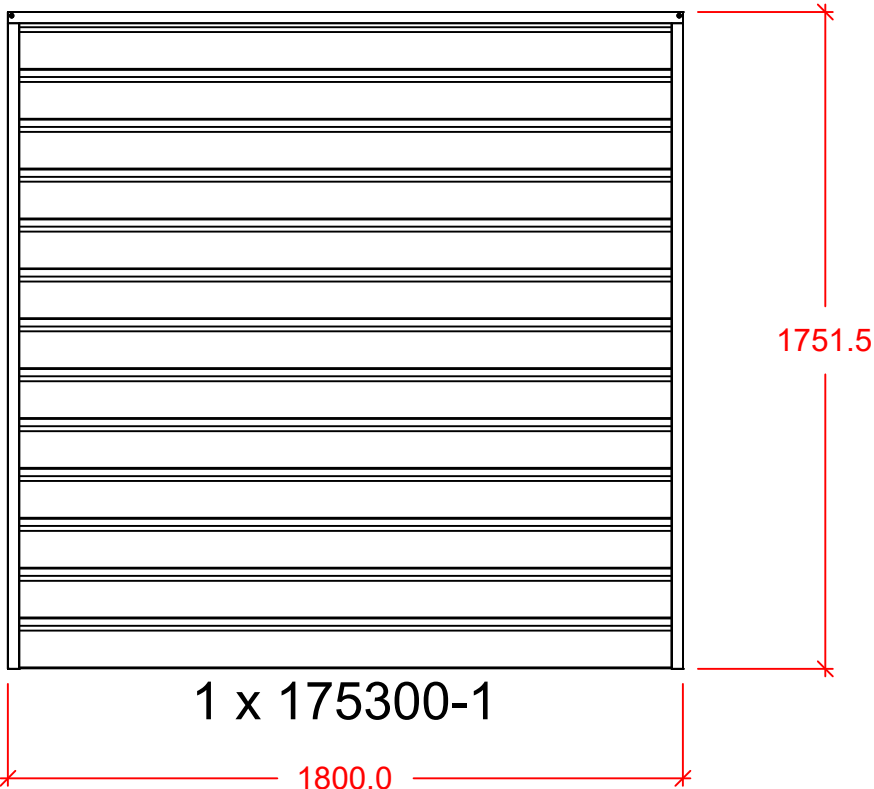

Før montering - SE MONTAGE VIDEO på www.plus.dk
Before assembly - SEE ASSEMBLY VIDEO at www.plus.dk
Vor der Montage - SIEHE MONTAGEVIDEO auf www.plus.dk
Avant le montage, regarder le MONTAGE VIDÉO sur www.plus.dk
Vóór de montage - ZIE MONTAGEVIDEO op www.plus.dk
Ennen asennusta - KS, ASENNUSVIDEO sivustola www.plus.dk
Före montering - SE MONTERINGSFILM på www.plus.dk

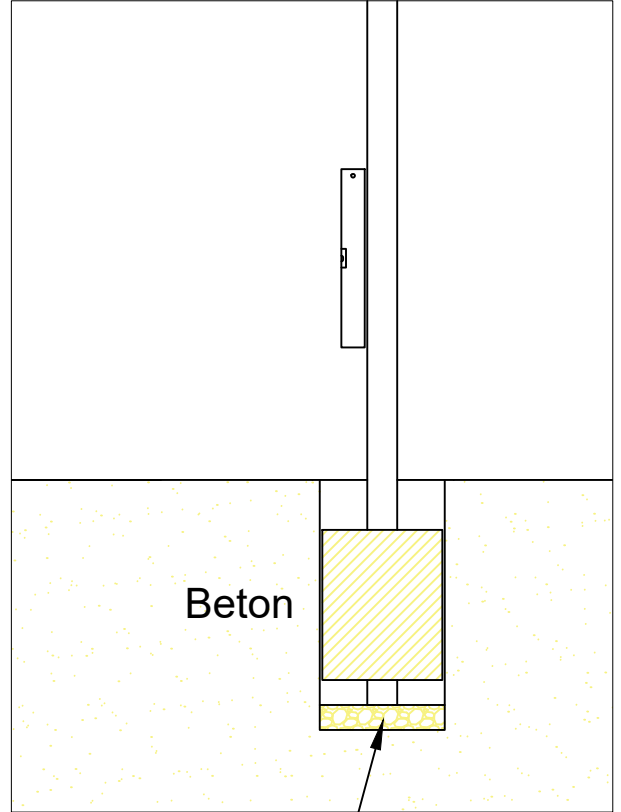
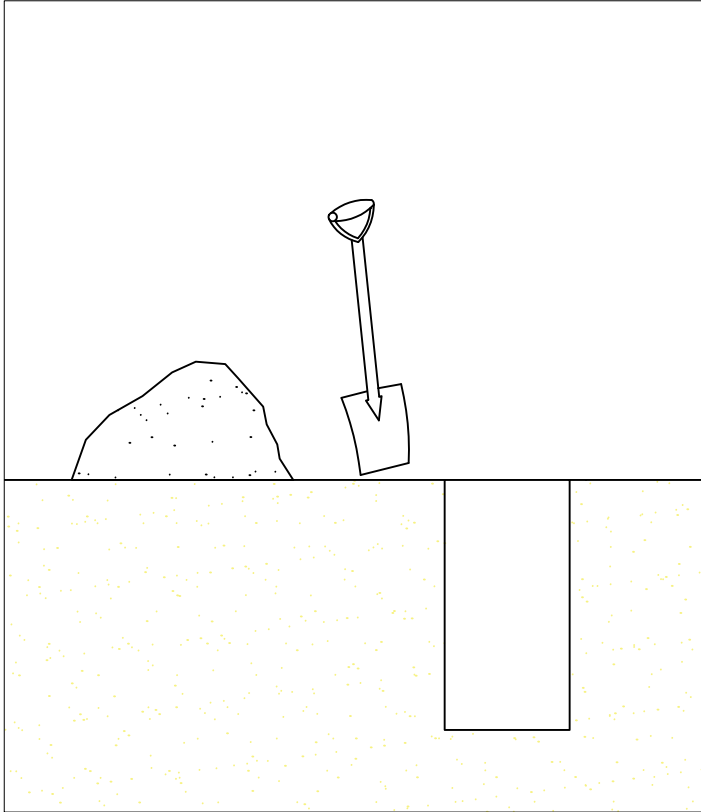
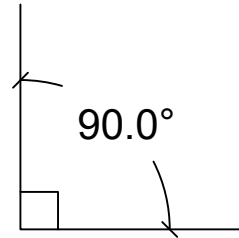
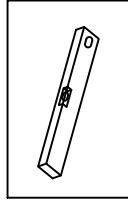
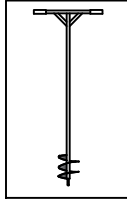
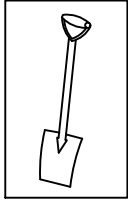
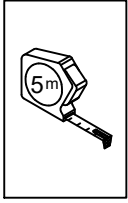

DK: Ingen beton under stolpen...!

UK: No concrete below the post...!

DE: Kein Beton unter der Pfosten...!

S: Ingen betong nedan stolpan...!

FIN: Ei betoni alla tolppaan...!

B/NL: Geen beton onder de post ...!

F: Pas de de béton sous ce poste ...!

10 cm grus

Gravel

Kies

Sora

grind

gravier

1 x B

1 x C

1 x C

180 cm

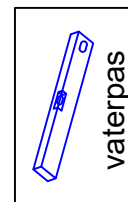
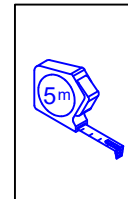
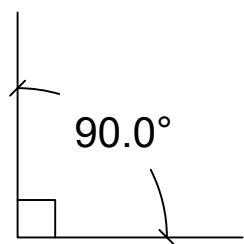

1 x B

180 cm



3-5 cm

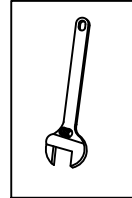
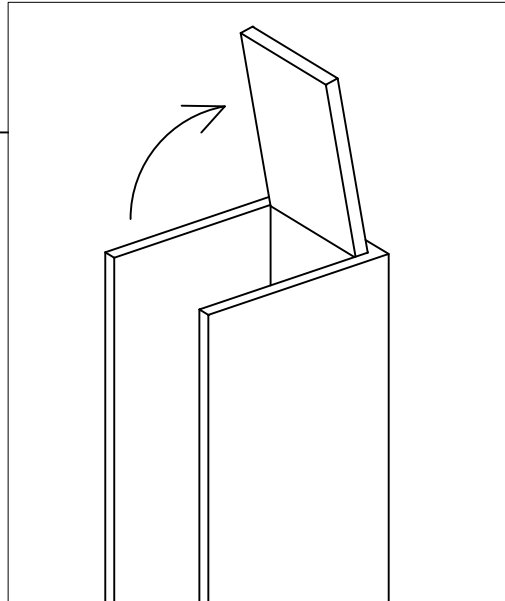
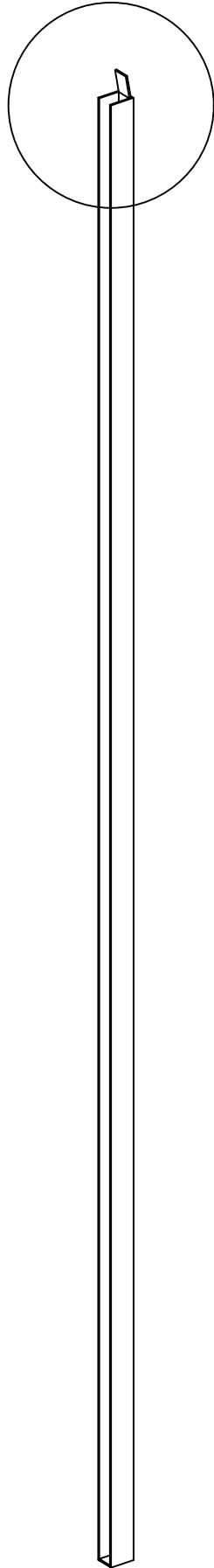
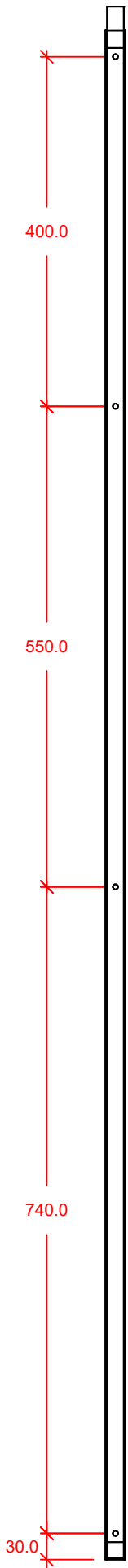

Vinklen bukkes forsigtigt op.

Gently bent the angle up.

Der Winkel gebogen ist, leicht nach oben.

L'angle est courbé légèrement vers le haut.

De hoek wordt gebogen zachtjes omhoog.

Kulma on taivutettu loivasti ylöspäin.

Vinkeln är böjd försiktigt uppåt.

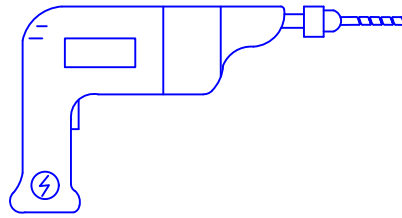
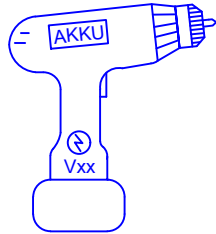
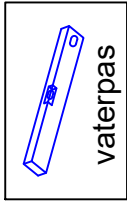
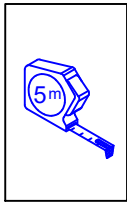

DK: Forbores
UK: Predrilled
DE: Vorbohren
F: Pré-forage
B/NL: Voorboren
FIN: Pora
S: Förborra

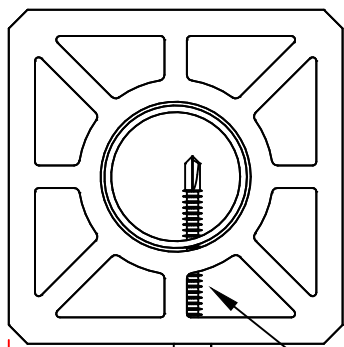

Monteret i Komposit.
 Assembled in composite.
 Montage auf Verbundwerkstoff.
 Monté sur matériau composite.
 Samengesteld composiet.
 Asennettu komposiittliin.
 Monterat i komposit.

5 cm

8 stk. skruer
 8 pcs. screws
 8 stck. Schrauben
 8 pièces des vis
 8 stuks. schroeven
 8 kpl. ruuvit
 8 st. skruvar

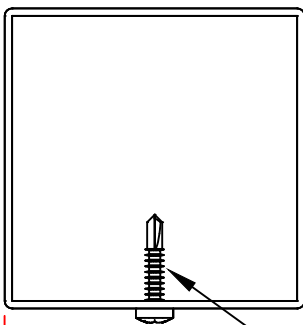

Monteret i stål.
 Assembled in steel.
 Montage auf Stahl.
 Monté sur acier.
 Samengesteld uit staal.
 Asennettu teräkseen.
 Monterat i stål.

X X

8 stk. skruer
 8 pcs. screws
 8 stck. Schrauben
 8 pièces des vis
 8 stuks. schroeven
 8 kpl. ruuvit
 8 st. skruvar

1 x C

90.0°

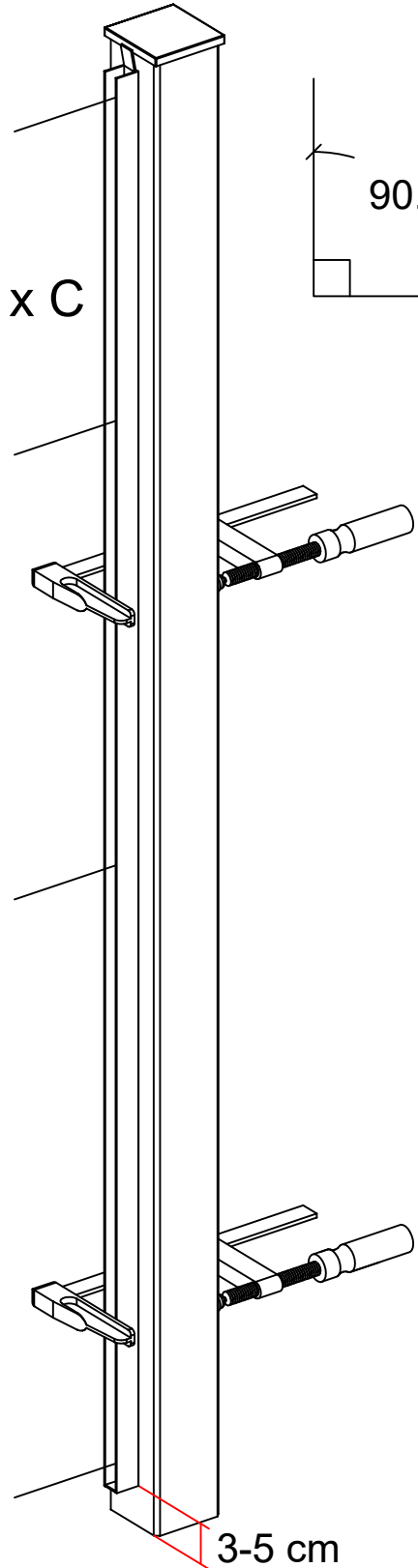

3-5 cm

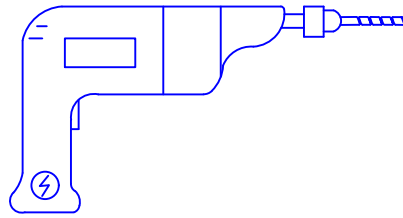
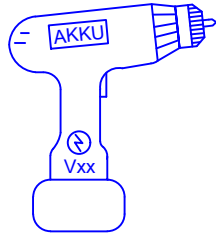
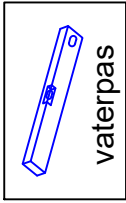
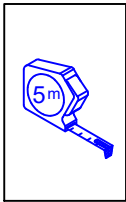

- DK:** Forbores
- UK:** Predrilled
- DE:** Vorbohren
- F:** Pré-forage
- B/NL:** Voorboren
- FIN:** Pora
- S:** Förborra

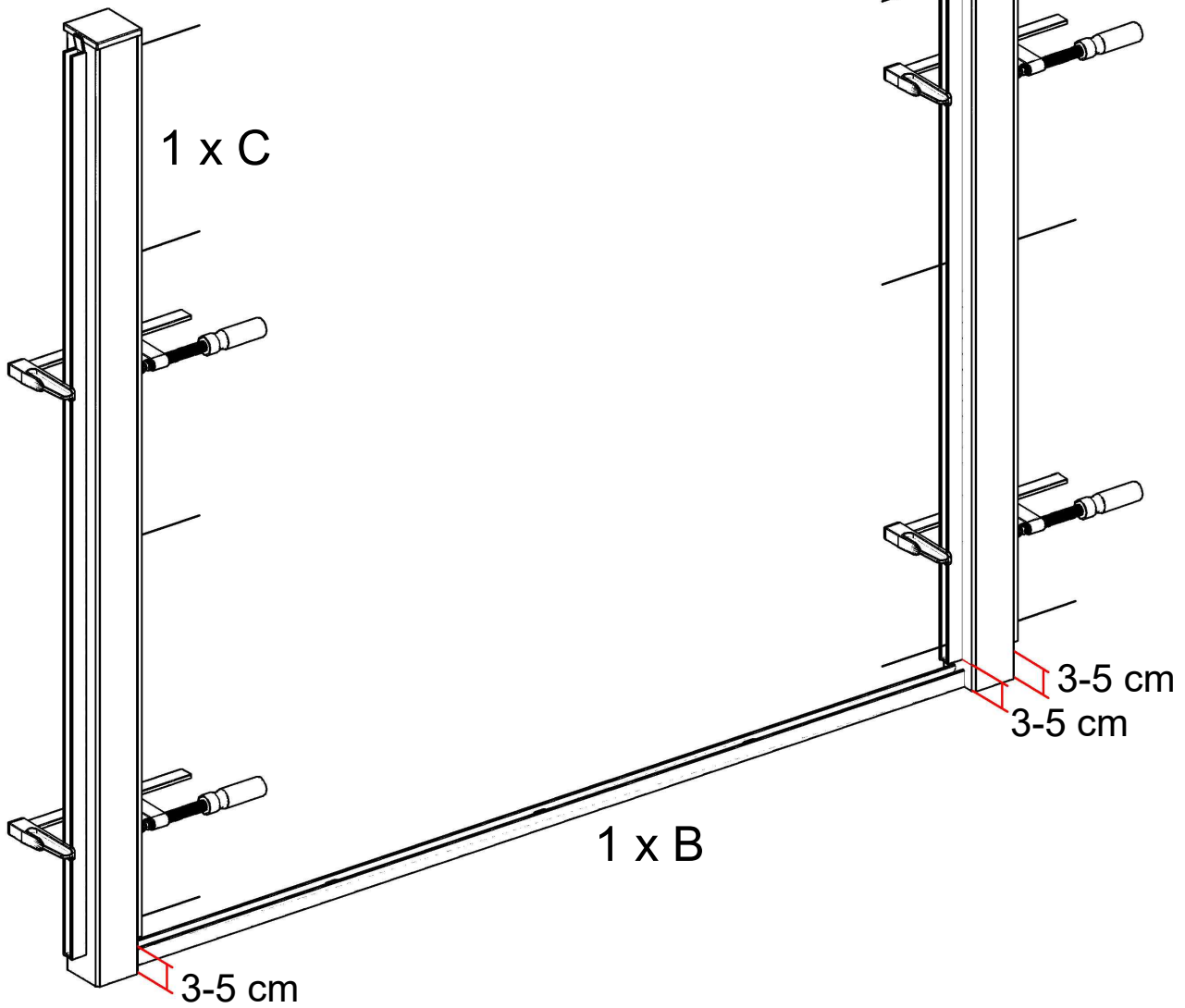
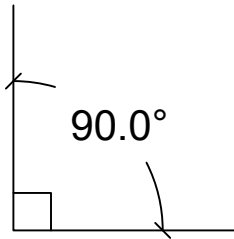

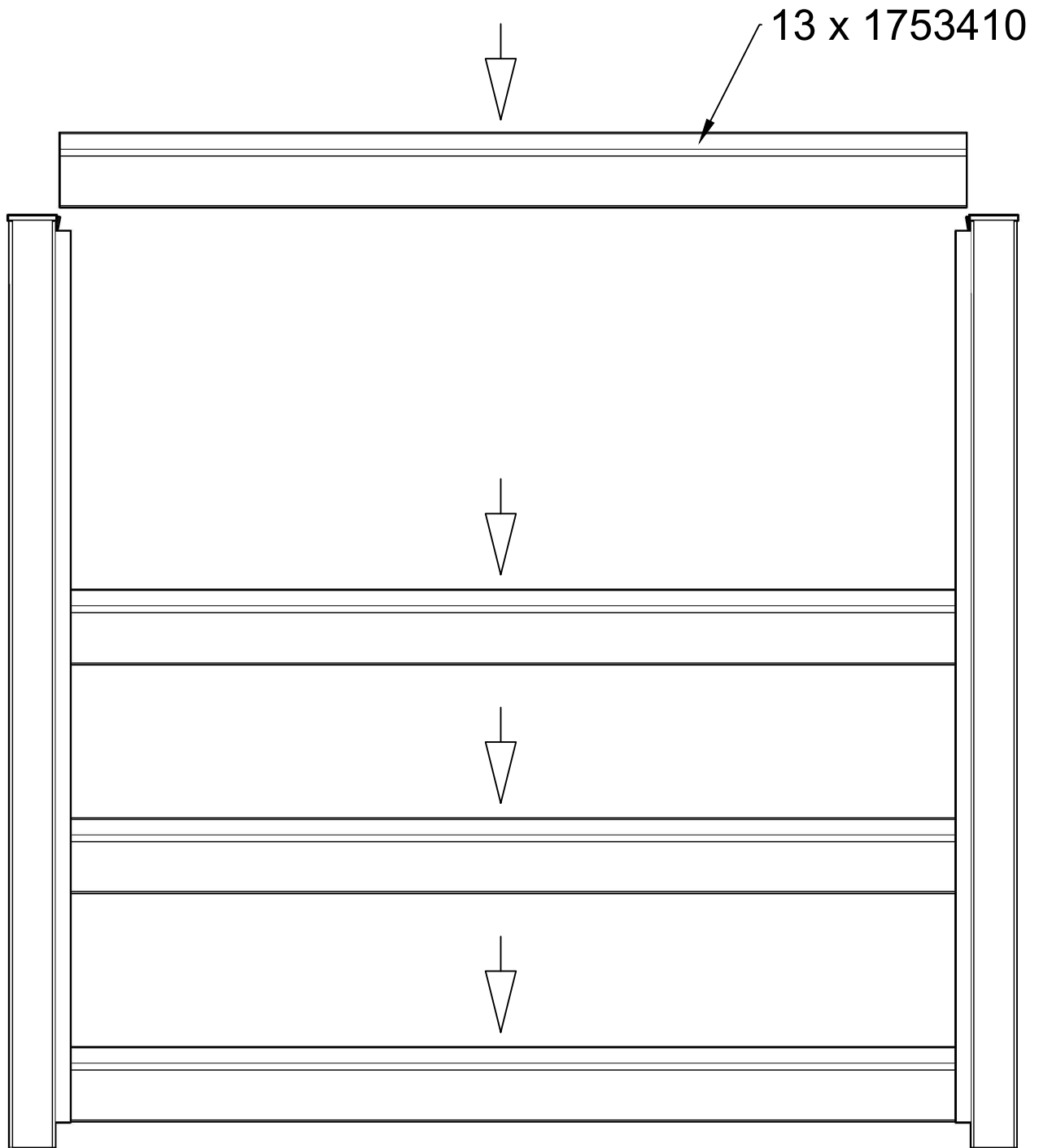
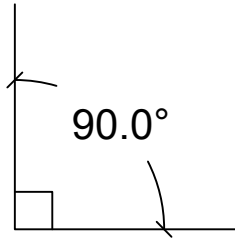
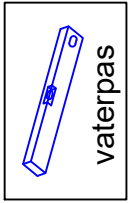
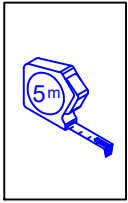

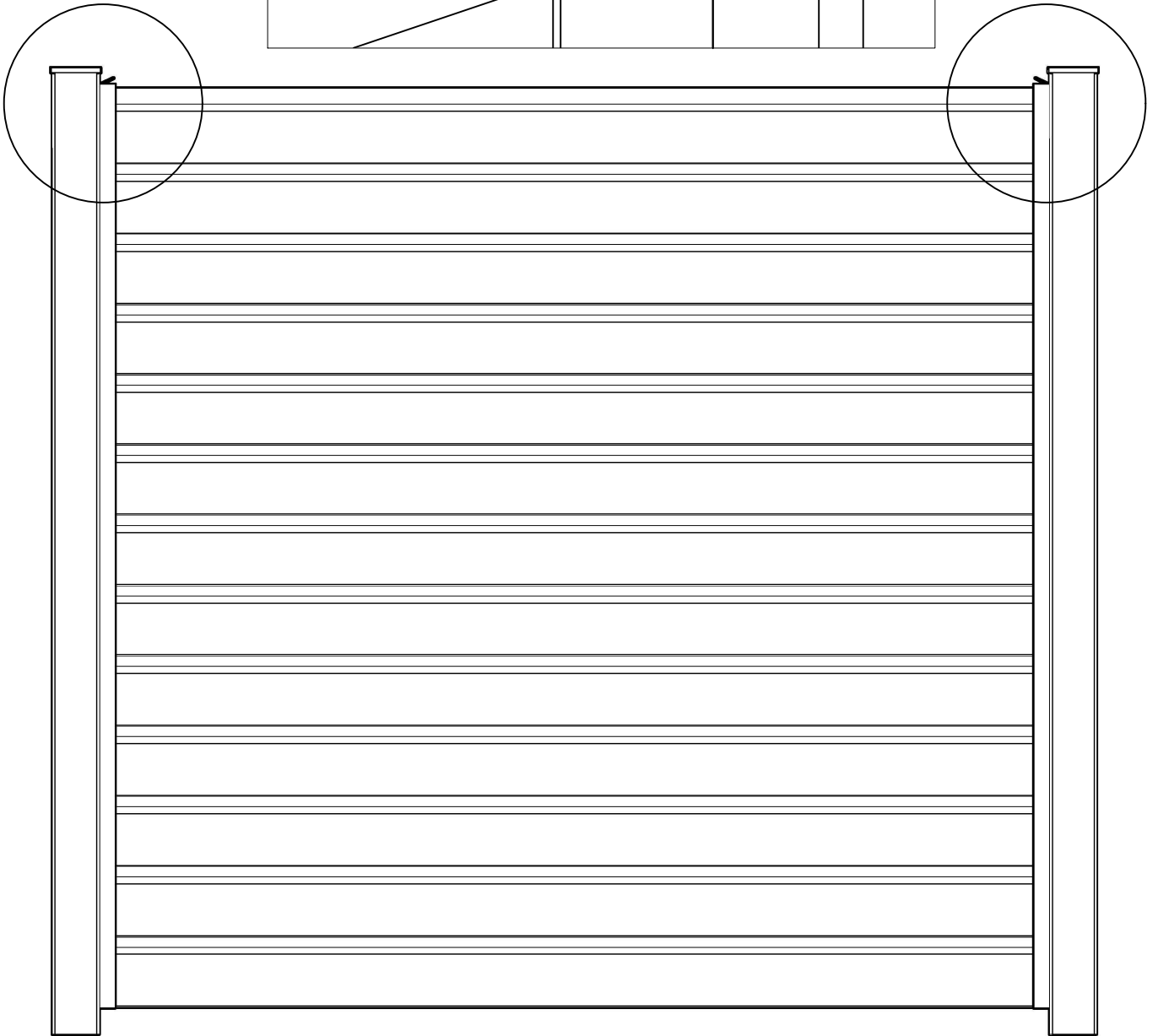
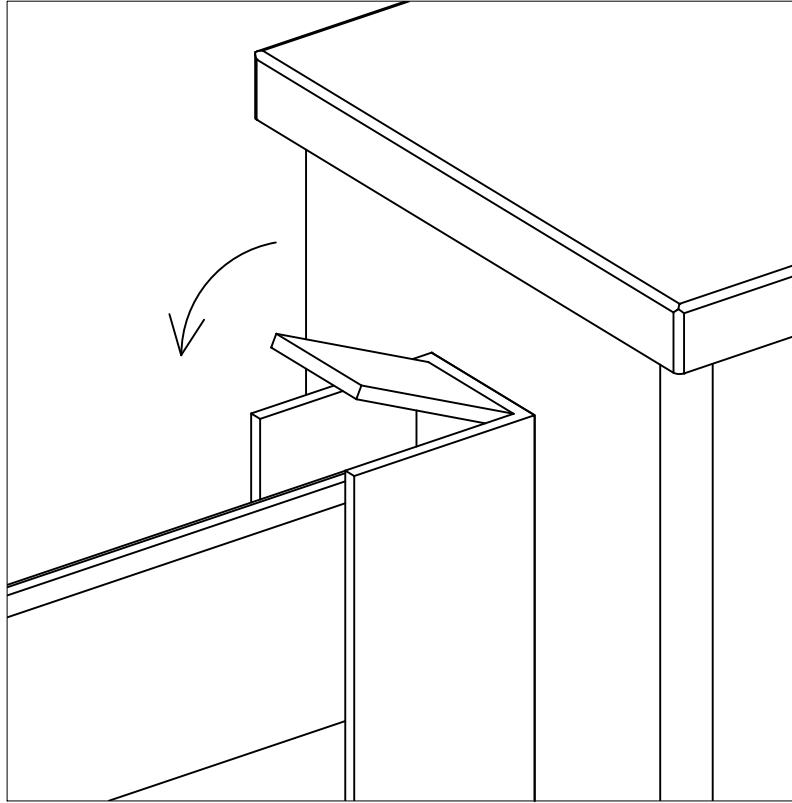
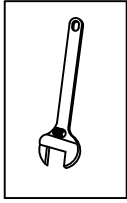

Monter toplisten.
 Mount the top strip.
 Obere Leisten montieren.
 Monter à nouveau la corniche.
 Hermonteer het bovenste profiel.
 Asenna yläkiskossa.
 Montera topplisten.

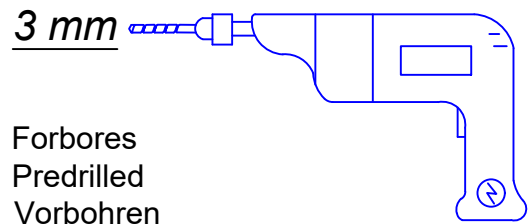
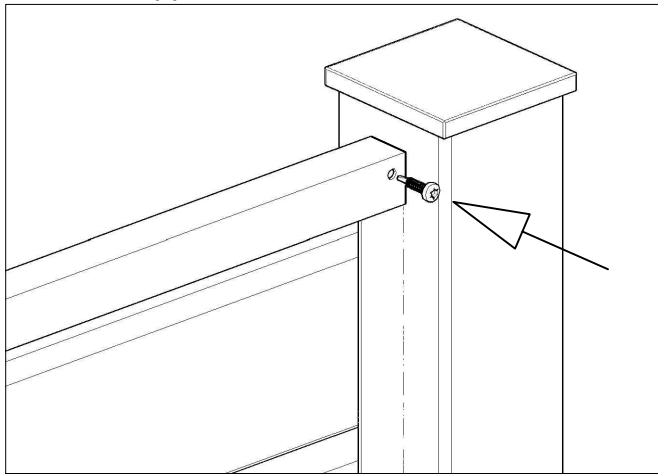
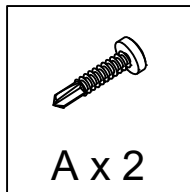

DK: Forbores
UK: Predrilled
DE: Vorbohren
F: Pré-forage
B/NL: Voorboren
FIN: Pora
S: Förborra

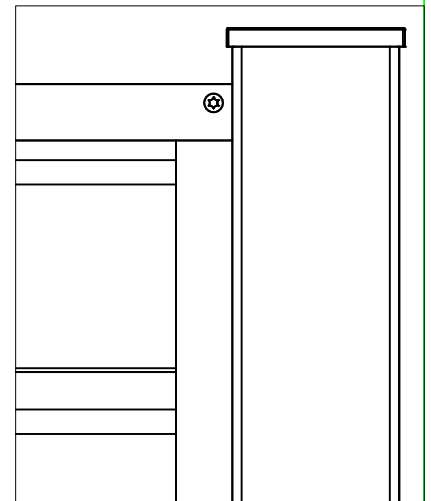
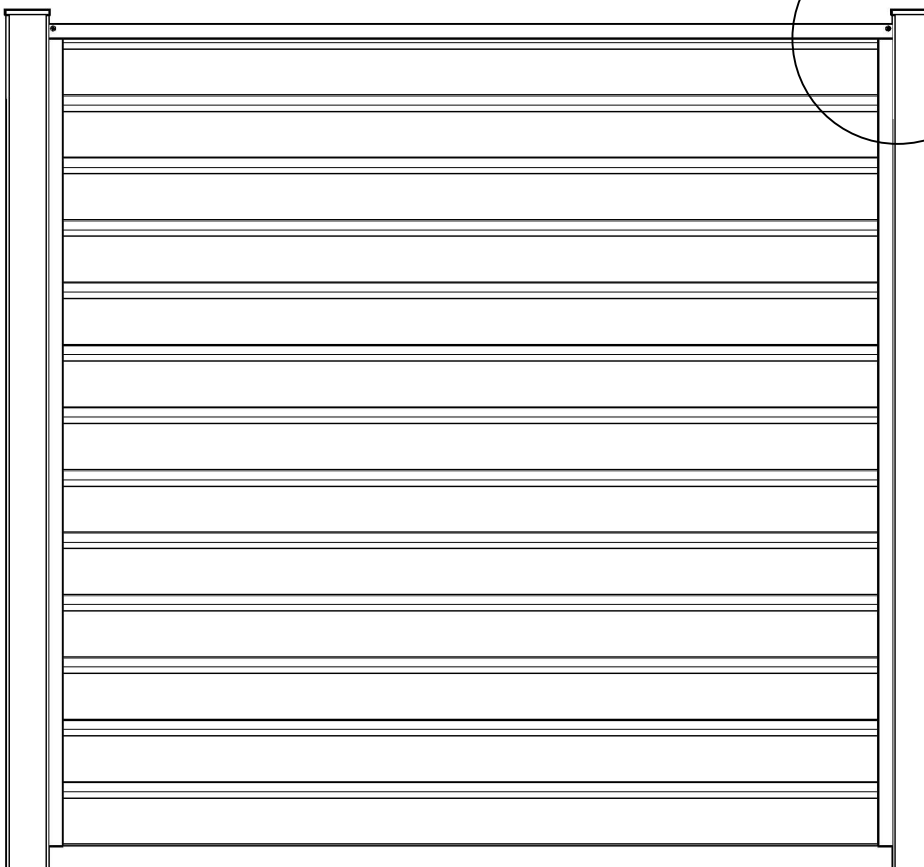
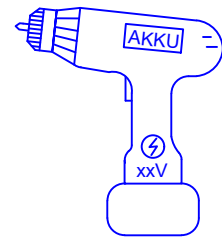

Se www.plus.dk for yderligere information og vedligehold af materialer.
 See www.plus.dk for additional information and maintenance of materials.
 Weitere Informationen sowie Wartungsanweisungen für die Materialien erhalten Sie auf www.plus.dk.
 Se reporter au site www.plus.dk pour de plus amples informations et pour l'entretien des matériaux.
 Zie www.plus.dk voor aanvullende informatie en het onderhoud van de materialen.
 Sivustolta www.plus.dk löydät lisätietoja ja materiaalien ylläpito-ohjeet.
 Se www.plus.dk för ytterligare information och materialunderhåll.

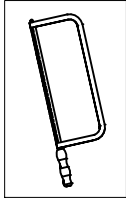
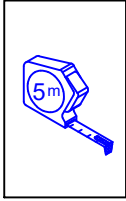

Zinkspray anbefales.
Zinc spray is recommended.
Zink-Spray wird empfohlen.
Zinc spray est recommandé.
Zinkspray aanbevolen.
Sinkki spray suositellaan.
Zink spray rekommenderas.

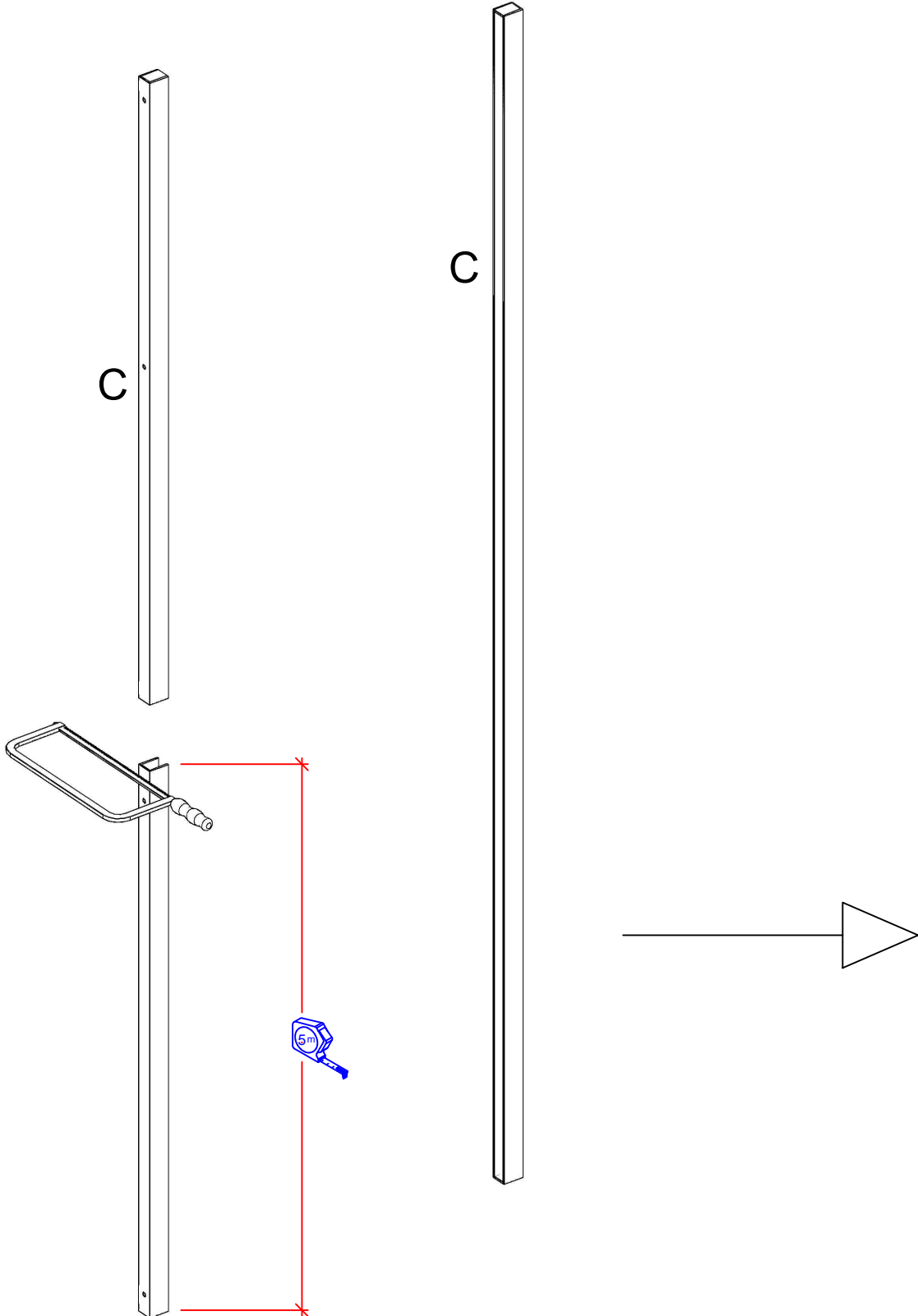

DK: Afstand mellem profiler og planker.

UK: Distance between structural sections and boards.

DE: Abstand zwischen den Profilen und Brettern.

F: Distance entre profils et planches.

B/NL: Afstand tussen de structuuronderdelen en panelen.

FIN: Ponttilautojen ja lankkujen välinen etäisyys.

S: Avstånd mellan profiler och plankor.

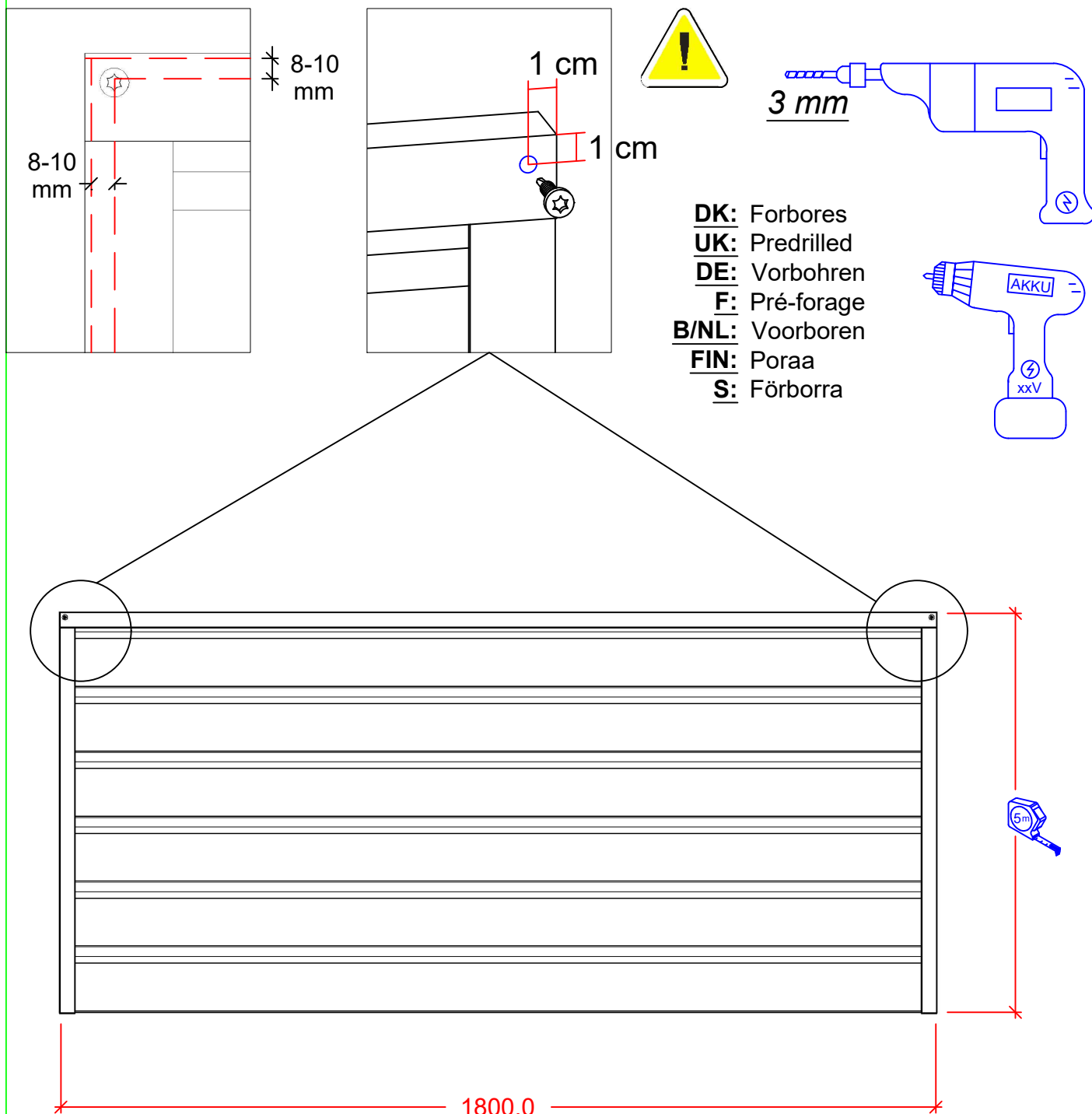

Zinkspray anbefales.
 Zinc spray is recommended.
 Zink-Spray wird empfohlen.
 Zinc spray est recommandé.
 Zinkspray aanbevolen.
 Sinkki spray suositellaan.
 Zink spray rekommenderas.

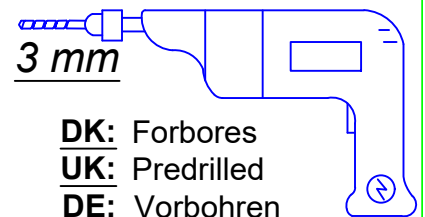
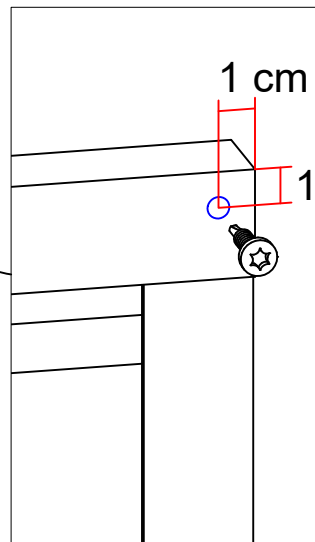
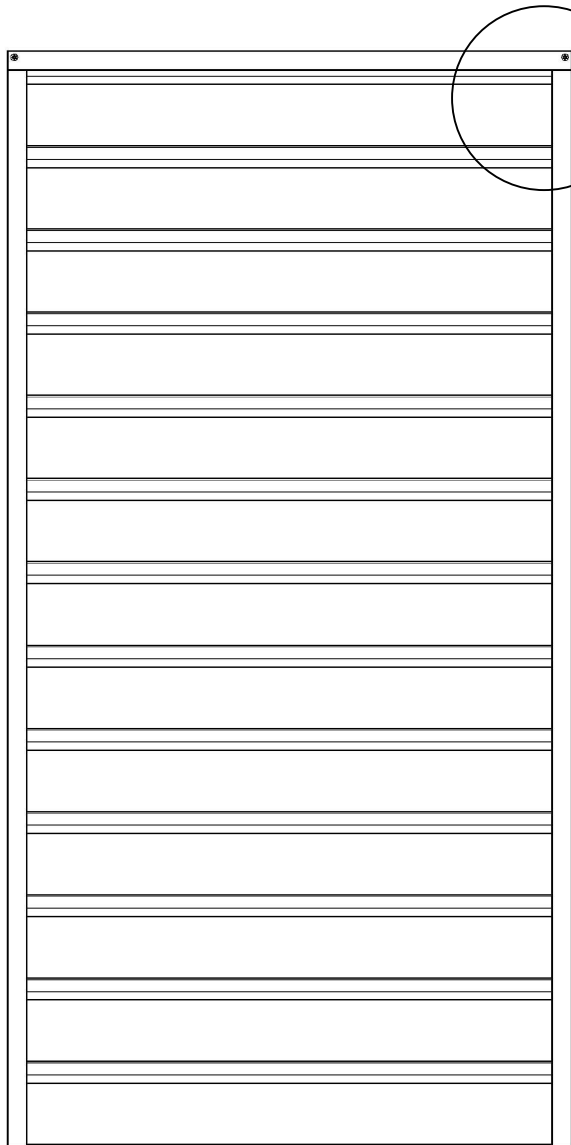
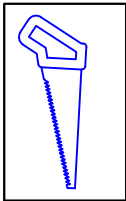
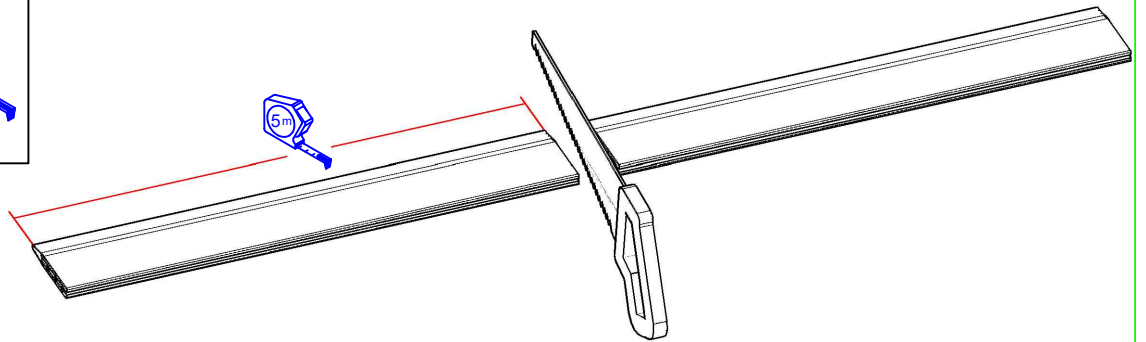
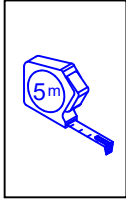
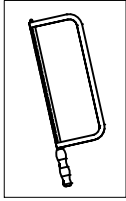
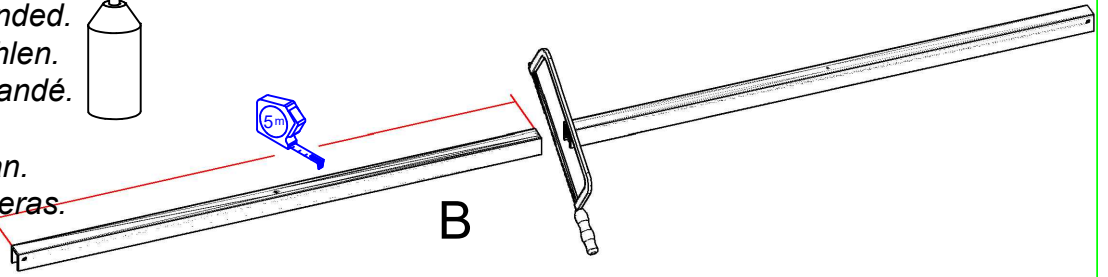
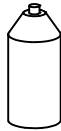

- DK:** Forbores
- UK:** Predrilled
- DE:** Vorbohren
- F:** Pré-forage
- B/NL:** Voorboren
- FIN:** Poraa
- S:** Förborra

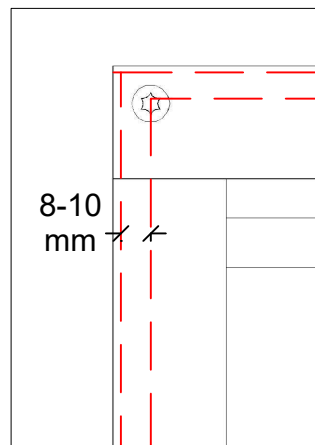

8-10 mm

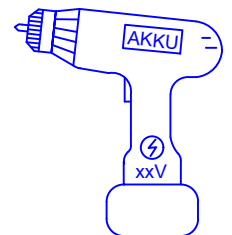

- DK:** Afstand mellem profiler og planker.
- UK:** Distance between structural sections and boards.
- DE:** Abstand zwischen den Profilen und Brettern.
- F:** Distance entre profils et planches.
- B/NL:** Afstand tussen de structuuronderdelen en panelen.
- FIN:** Ponttilautojen ja lankkujen välinen etäisyys.
- S:** Avstånd mellan profiler och plankor.

